

CLARITY

HEMOGLOBIN TESTING SYSTEM

USER'S MANUAL



CLIA WAIVED

FOR *IN VITRO* DIAGNOSTIC USE ONLY.

CUSTOMER SERVICE: 877.722.6339

TECHINICAL SUPPORT: 877.485.7877

Table of Contents

Section 1	Introduction	1
Section 2	Getting Started	3
Section 3	Components	5
	Meter.....	5
	Test Cartridges.....	8
	Optical Verifiers.....	11
	Control Solution.....	12
Section 4	Initial Setup	13
	Turning the Meter On.....	13
	Coding the Meter.....	14
Section 5	Meter Setup and Options	15
	Test Number Setup.....	16
	System Setup.....	17
Section 6	Testing	20
	Specimen Collection.....	20
	Test Processing.....	24
Section 7	Meter Memory	28
	Viewing Memory.....	28
	Deleting Data.....	29
Section 8	Optical System Check	30
Section 9	Quality Control Testing	32
	Control Solution Testing.....	32
	Interpreting results.....	33
Section 10	Maintenance	34
	Cleaning.....	34
	Disinfection Process.....	35
	Replacing the Batteries.....	36
Section 11	Precautions	38
Section 12	Troubleshooting	39
Appendix 1	Meter Specifications	40
Appendix 2	Warranty	41

Section 1 Introduction

The Clarity HbCheck Hemoglobin Testing System is for the quantitative determination of hemoglobin in non-anticoagulated capillary whole blood or anticoagulated venous whole blood in EDTA (K2, K3, Na2) or sodium heparin. The testing system is designed for point-of-care use in primary care settings. Estimation of hematocrit is only for hemoglobin values from 12.3 to 17.5 g/dL (123 to 175 g/L).

The Clarity HbCheck Hemoglobin Control Solution is intended to validate hemoglobin testing using the Clarity HbCheck Hemoglobin Testing System.

The Clarity HbCheck Hemoglobin Testing System is for professional *in vitro* diagnostic use only.

This device has not been evaluated for pediatric subjects.

Principle of Operation for the Methodology

The Hemoglobin Test Cartridge includes a mesh covered sample reaction zone. Specimen is applied to the center of the sample reaction zone. The mesh functions to separate the sample evenly on the entire reaction layer. The reagents on the reagent layer function to hemolyze and release the hemoglobin. The hemoglobin is converted to methemoglobin to cause a color change on the cartridge.

The meter reads the reflection of the cartridge at 525 nm every second until the end point of the reaction is detected. The reflection at the end point is directly proportional to the hemoglobin concentration. The end point is defined as following:

The reflection changes between $\pm 1\%$ in three continuous second. Then the reflection at the last second will be read as the end point.

NOTE: The normal hemoglobin, whatever Oxy-hemoglobin or CO²-hemoglobin, they are all with Fe²⁺. After the Fe²⁺ is converted to Fe³⁺, the hemoglobin is converted to methemoglobin; the color will change to brown.

The Clarity HbCheck Hemoglobin Testing System provides results in less than 15 seconds. The test only requires a single 10 μ L drop of whole blood. The meter can store up to 1,000 results and can be powered by 4 AAA (1.5V) batteries or an optional AC adapter.

To ensure accurate results:

- Read instructions carefully. Complete any necessary training before use.
- Use the Code Chip included in each box of test cartridges.
- Only use Clarity HbCheck Hemoglobin Test Cartridges with the Clarity HbCheck Hemoglobin Meter.
- For *in vitro* diagnostic use only.
- For professional use only.
- Test only whole blood specimens. Blood samples with EDTA-K2, EDTA-K3, EDTA-Na2 or sodium heparin anticoagulants can be used.
- This device has not been evaluated for pediatric subjects.
- Keep out of reach of children.
- For help with any additional questions or issues, please contact Customer/Technical Support at 1-877-485-7877.

Section 2 Getting Started

Inspect the kit box, meter, and accessories for any visible damage, contact Customer/Technical Support at 1-877-485-7877.

Before testing, read the instructions carefully and learn about all the components of the Clarity HbCheck Hemoglobin Testing System. Depending on the package type you chose, some of the components may need to be purchased separately. Please check the list of contents on the outer box for details on which components are included with your purchase. The following items are needed to perform a test:



Hb Meter



Code Chip



Test Canister



Optical Verifier



Control Solutions



Capillary Transfer Tube



Safety Lancet

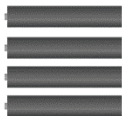

AAA Batteries



Carrying Case

Clarity HbCheck Hemoglobin Meter: Reads the Test Cartridges. Displays the Hemoglobin concentration and the estimated hematocrit (Hct) value.

Clarity HbCheck Hemoglobin Test Cartridges: Used with the meter to measure the Hb concentration and the calculated Hct value in blood.

Code Chip: Automatically calibrates the meter with the code number, once it is inserted into the meter.

Clarity HbCheck Hemoglobin Optical Verifier: Verifies the proper operation of the meter's optical system.

Clarity HbCheck Hemoglobin Control Solution: To confirm that the test cartridges and meter are working together properly and that the test is being performed correctly. Before using your meter, review **Section 9 Quality Control** for detailed instructions on running quality control tests. Clarity HbCheck Hemoglobin Control Solution package is sold separately

Clarity HbCheck Capillary Transfer Tubes: Needed to collect 10 μ L of capillary blood from the fingertip for accurate results.

AAA Batteries: Provide power for the meter.

Carrying Case: Provides portability for testing wherever you go.

User's Manual: Provides detailed instructions on how to use the Hemoglobin Testing System.

Quick Reference Guide: Provides a brief overview of the Hemoglobin Testing System and testing procedures.

Clarity HbCheck Hemoglobin Test Cartridges Package Insert: Provides detailed instructions on how to use the Hemoglobin Test Cartridges.

Clarity HbCheck Hemoglobin Optical Verifier Package Insert: Provides detailed instructions on how to use the Hemoglobin Optical Verifiers.

Clarity HbCheck Hemoglobin Control Solution Package Insert: Provides detailed instructions on how to use the Hemoglobin Control Solutions.

Warranty Card: Should be completed and returned to the Warranty Center to qualify for the 3-year meter warranty.

Section 3 Components

The Clarity HbCheck Hemoglobin Meter reads the test cartridges and displays the Hemoglobin concentration and the estimated hematocrit (Hct) value. Use this diagram to become familiar with all the parts of the meter.

Meter

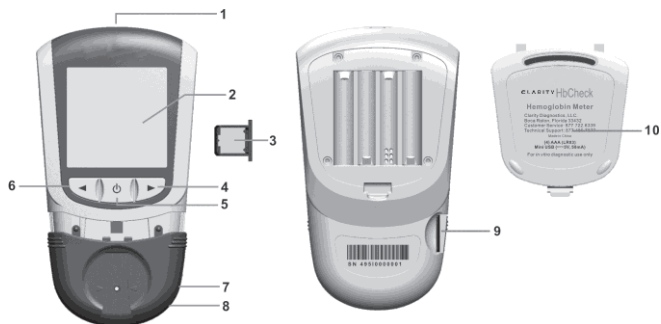

- | | | | |
|---|---|----|------------------------|
| 1 | USB Port | 6 | Left Arrow Button |
| 2 | Liquid Crystal Display (LCD) | 7 | Test Cartridge Channel |
| 3 | Code Chip | 8 | Test Cartridge Holder |
| 4 | Right Arrow Button | 9 | Code Chip Slot |
| 5 | On/Off Button  | 10 | Battery Cover |

Meter Display

During testing, the Clarity HbCheck Hemoglobin Meter will display icons showing the status, options available, and prompts for testing:

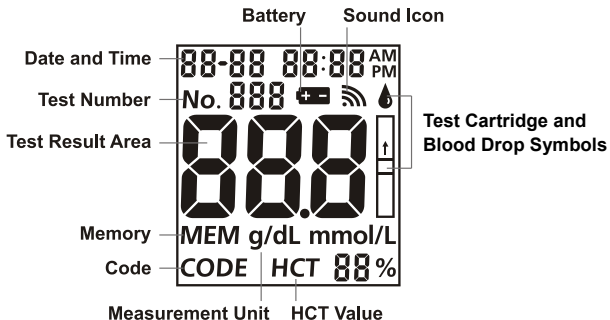

Sound Icon: Appears when the sound is turned on.

Battery: Displayed when the battery should be replaced.

Test Number: Indicates the assigned test number.

Test Result Area: Displays the test result or menu options.

Memory: Shows a test result is being recalled from memory.

Code: Indicates the code number of the Test Cartridges.

Measurement Units: Displays the units of the test result.

Hct Value: Shows the estimated Hct value.

Note: If the Hb result is outside this range of 12.3 g/dL - 17.5 g/dL, then the estimated hematocrit result will not be calculated and "--" will appear.

Test Cartridge and Blood Drop Symbols: Indicates when to insert a Test Cartridge or apply a specimen.

Meter Use and Precautions

- Do not get water or other liquids on or inside the meter.
- Keep the test cartridge channel clean.
- Keep the meter dry. Avoid exposure to extreme temperatures or humidity.
- Do not drop the meter or get it wet. If either has occurred, ensure the meter is working properly by running an **Optical Check**. Refer to **Section 8 Optical System Check** for details.
- Do not take the meter apart. This will void the warranty.
- Refer to **Section 10 Maintenance** for details on how to clean the meter.
- Keep the meter and all associated parts out of reach of children.

Note: Follow proper precautions and all local regulations when disposing of the meter and used batteries.

All Hb Systems Preventive Warnings with Regard to EMC

1. This instrument is tested for immunity to electrostatic discharge, as specified in IEC 61000-4-2. However, use of this instrument in a dry environment, especially if synthetic materials are present (synthetic clothing, carpets, etc.) may cause damaging static discharges that can cause erroneous results.
2. This instrument complies with the emission and immunity requirements described in EN 61326-1 and EN 61326-2-6. Do not use this instrument in close proximity to strong sources of electromagnetic radiation. These may interfere with proper operation of the meter.
3. For professional use, the electromagnetic environment should be evaluated prior to operation of the system.

Test Cartridges

The Clarity HbCheck Hemoglobin Test Cartridges are made out of plastic. A reagent layer within the test cartridge contains a chemical reagent system that works with the Clarity HbCheck Hemoglobin Meter to measure the Hemoglobin concentration in capillary and venous whole blood.

Each Test Cartridge appears as shown:



Insert Arrows: Located on the front of the test cartridge. These arrows indicate the direction in which the test cartridge should be inserted.

Specimen Application Area: After the test cartridge is inserted into the Cartridge Channel, apply 10 μ l of blood to the hole in the center of the test cartridge.

Handle: Located on the end of the test cartridge. This handle is used to insert and remove the test cartridge from the meter. See below.

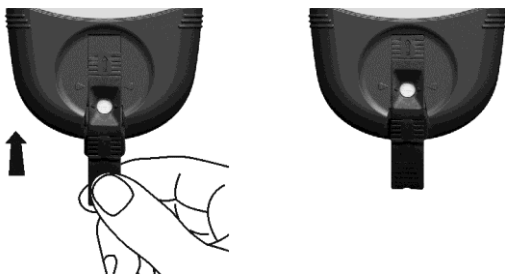

Specimen Application

For best results, fill the specimen application area with approximately 10 μL of blood. Incorrect results may occur if the specimen is not applied correctly or if the specimen application area is not filled.

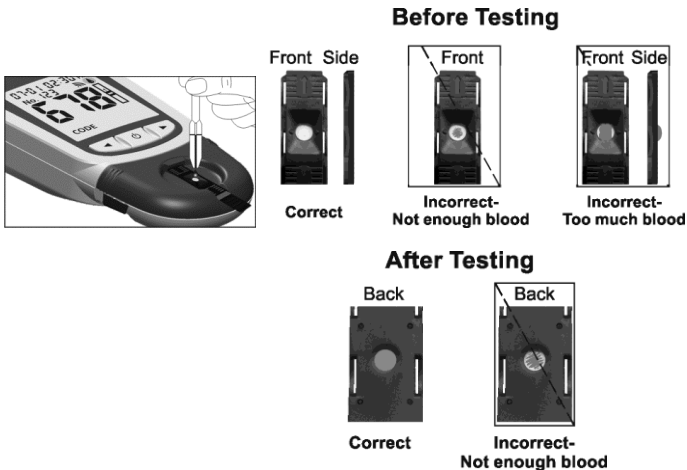

After applying the specimen, ensure the specimen application area is completely covered as the above picture show. This area should remain covered throughout the entire test. If it is not covered, or if there is too much specimen covering the area, repeat the test with a new test cartridge.

Note: Do not apply a second sample. When a "Lo" or "E-5" appears on the display, check the back side of the specimen application area to confirm whether or not enough blood has been applied as in the above picture. Discard the used cartridge and retest with a new cartridge if not enough blood had been applied.

Code Number

Each canister of test cartridges is printed with a code number (**Code**), lot number (**Lot**), unopened expiration date (**Exp**), and test quantity (**Quantity**). Whenever a new canister is opened, mark the date on the label. Calculate the opened expiration date by adding three months. Record this date on the label.

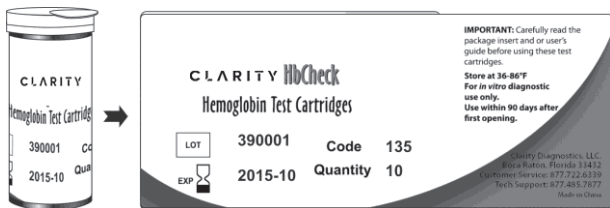

Test Cartridge Precautions and Instructions for Use

- Test cartridges must be stored in the original canister with the cap tightly closed.
- Replace the cap on the test cartridge canister immediately after removing a test cartridge.
- A new canister of test cartridges may be used for 3 months after first being opened. The opened expiration date is 3 months after the date the canister was first opened. Write this date on the canister label after opening. Discard the canister 3 months after it was first opened. Usage after this period may result in inaccurate readings.
- For *in vitro* diagnostic use. Test cartridges are only to be used outside the body for testing purposes.
- Do not use test cartridges that are damaged in any way. Do not reuse test cartridges.
- Before testing, make sure that the code number on the meter display matches the number shown on the test cartridge canister label and the ink-jet printing on the code chip.

Refer to the test cartridge package insert for more details.

Optical Verifiers

The Clarity HbCheck Hemoglobin Optical Verifiers are made out of plastic and contain a brown reference pad, which works with the Clarity HbCheck Hemoglobin Meter to ensure the optical system is working properly. After the optical verifier is inserted into the meter, the meter's optical system detects the color intensity of the optical verifier. The meter displays **YES** or **no** to show whether the meter is functioning properly. Refer to **Section 8 Optical Check** for details.

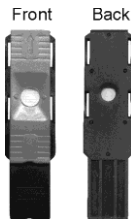

The optical verifiers look as shown right side.

Note: The optical verifier is similar to the test cartridge, but it is grey in color.

Precautions

- Keep the optical verifiers clean. Do not bend. Do not touch the test area of the verifiers.
- Remove the optical verifier for immediate use. Replace the cap on the optical verifiers' canister immediately.
- Immediately after use, place the optical verifier back into its canister, and close the canister tightly. Do not use contaminated, discolored, or damaged optical verifiers.
- Do not use the optical verifiers after the expiration date.
- For *in vitro* diagnostic use only.

Storage and Handling

- Store the optical verifiers in their protective canister in a cool, dry place. Store away from heat, direct sunlight and 85% humidity or above.
- Transport and store the optical verifiers in their closed canister within 36-86 °F (2-30 °C) with less than 85% humidity.
- Do not freeze or refrigerate
- Do not use optical verifiers past the unopened expiration date printed on the label. Using the optical verifiers past this date may cause incorrect test results.
- The optical verifiers will expire 12 months after the canister is opened for the first time. After opening the canister for the first time, record this opened expiration date on the canister label.

Note: The expiration date is printed in a Year/Month format.

For example, 2013/01 is January, 2013.

Control Solution

Clarity HbCheck Hemoglobin Control Solution is a liquid, stable control solution prepared from bovine hemoglobin with added chemicals, preservatives and stabilizers. The control solution does not contain products of human origin, and is packaged with 3 levels; Control Solution 0 (low), Control Solution 1 (Normal) and Control Solution 2 (High). If the Clarity HbCheck Hemoglobin Testing System is working properly, the Hb value will be within the range of the accepted values printed on the control vial label.



Note: The Clarity HbCheck Hemoglobin Control Solution is intended to validate hemoglobin testing using the Clarity HbCheck Hemoglobin Testing System. All three levels of control solutions must be tested and all levels have to be within the assigned values.

The control solution package insert should be read before using the controls. Refer to the control vial label for acceptable ranges for that control solution lot. The system is working properly if the control value displayed by the meter is within the acceptable range printed on the vial label. If the value is not within the ranges, see the **Control Solution Package Insert** for further instructions, and repeat the test. If the results are outside of the acceptable ranges again, please contact Customer/Technical Support at 1-877-485-7877 for additional information.

Note: We recommend using only Clarity HbCheck Hemoglobin Control Solutions with your meter.

Storage and Handling

- Store the control solution at a temperature between of 36 - 46 °F (2 - 8 °C).
- Do not freeze.
- If the control solution is cold, do not use until it has warmed to a temperature between 59 - 86 °F (15 - 30 °C).
- Use before the expiration date shown on the vial.
- Each vial of control solution can be used for 30 days after you first open it. The control solution will expire 30 days after the vial is opened for the first time. Record this opened expiration date on the vial label.

Note: The expiration date is printed in a Year/Month format.

For example, 2013/01 is January, 2013.

Section 4 Initial Setup

Before testing, ensure the following procedures are followed:

Turning the Meter On

The meter can be operated using the certified AC Adapter or four (4) AAA batteries (1.5 V).

To use the meter with batteries, insert four (4) AAA batteries (1.5 V) into the battery compartment located in the back of the meter.

To use the meter with the power adapter, connect the Mini USB port of the power adapter to the USB port located on the top of the meter. Plug the adapter into a 100-240 Volt AC, 50-60 Hz primary power outlet.

The meter can be powered with rechargeable batteries; however they should be removed from the meter for charging. The optional AC power adapter will not recharge batteries inside the meter.



OR

The meter will turn on automatically after the batteries are inserted. The meter will display the date and time setup screen. Refer to **Section 5 Meter Setup** for details. After the date and time have been set, the meter will automatically turn off.

Press  to turn the meter back on. The screen will briefly display all of the LCD symbols. Observe the LCD at startup to ensure all segments and display elements are turned on. No icons or elements should be missing. After startup, ensure that there are no permanently turned on segments or icons. After the power-on diagnostic check, the Initial screen will be displayed.

The meter will turn off automatically after 8 minutes of inactivity.

Coding the Meter

Each time a new box of test cartridges is used, a new code chip must be inserted into the meter. This code chip can be found inside the box of new test cartridges. Take the code chip from the test cartridges box. Compare the code number on the code chip with the code number printed on the canister label. Results may be inaccurate if the two numbers are not identical. Please contact Customer/Technical Support at 1-877-485-7877 if the code number on the code chip does not match the number on the canister label in which it was packaged.

Insert the new code chip into the code chip slot of the meter. It should easily snap into place. The code chip should remain in the meter. Do not take it out until a new box of test cartridges is needed. The code number will appear on the initial screen after startup.

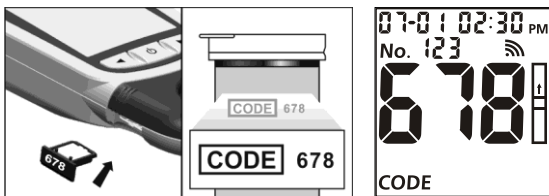

Please contact Customer/Technical Support at 1-877-485-7877 if the code number on the code chip does not match the number that is displayed on the screen.

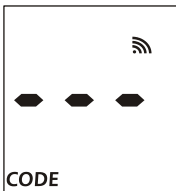

If the code chip is not properly inserted into the code chip slot, or if it is missing, the meter will display **three dashes** as shown below.





Section 5 Meter Setup and Options

With the meter turned off, press and hold  for 4 seconds to enter the **Meter Setup** mode shown below.



Press  or  to display several setup sub-modes:

No. SEt	Test Number Setup mode.. The test number can be set from 1 to 999.
CHE	Optical Check mode. Refer to Section 8 Optical System Check .
SEt	Meter Setup mode. System setup, including date, time, test number reset, units, and sound.
dEL	Memory Delete mode. Refer to Section 7 Meter Memory .
EIt	Exit setup modes and save changes when  is pressed. The meter will automatically return to the Initial Screen.

Press  to enter the mode when the desired sub-mode is displayed.

Test Number Setup

From the **SEt** screen, press  to enter **No. SEt** mode.



The test number can be set to any number from 1 - 999.

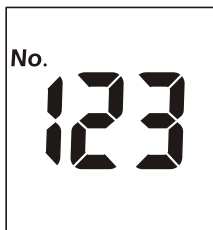

Press ◀ or ▶ until the correct test number is displayed. To quickly cycle to the desired test number, press and hold ◀ or ▶.

Press  to save and return to the **Meter Setup** screen.



Note: Once the meter reaches test number 999, the next test number will be 1.

Meter Setup

From the **SEt** screen, press  to enter **Meter Setup** mode.



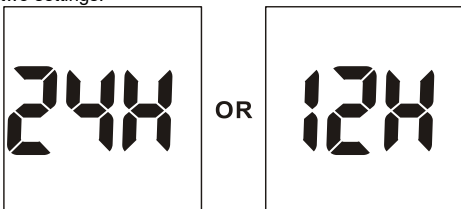

Hour Setup

The first option sets the clock to either **12** or **24** hour mode. Press  or  to switch between the two settings.



Press  to save and advance to setting the year.

Year Setup

The year will appear at the top of the display. Press  or  until the correct year is displayed.



Press  to save and start setting month and date.

Month and Date Setup

The month and date will appear at the top of the display. They will be separated by a single dash (-), with flashing month. Press ◀ or ▶ until the correct month is displayed.



Press ⏻ to save. The day will flash. Press ◀ or ▶ until the correct day is displayed. Then press ⏻ to save and proceed to setup time.

Time Setup

The hour and minutes will appear at the top of the display. They will be separated by a colon, with flashing hour.



Press ◀ or ▶ until the correct hour is displayed. Press ⏻ to save and proceed to setup minute.

Note: The meter will display **AM** or **PM** if the 12H time setting is chosen.

Minutes will flash. Press ◀ or ▶ until the correct Minutes are displayed. Press ⏻ to save and proceed to **Test Number Reset Setup**.

Test Number Reset Setup

Press ◀ or ▶ to turn the test number reset **ON** or **OFF**. The test number will reset to 1 for each new day of testing when the test number reset is turned on. Press ⏻ to save and proceed to setup unit.

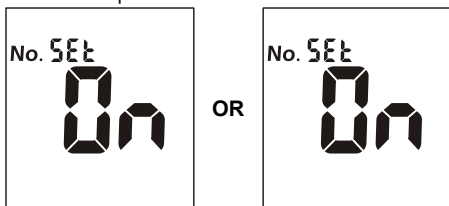

Units Setup

Press ◀ or ▶ to select either **g/dL**, **g/L**, or **mmol/L**.

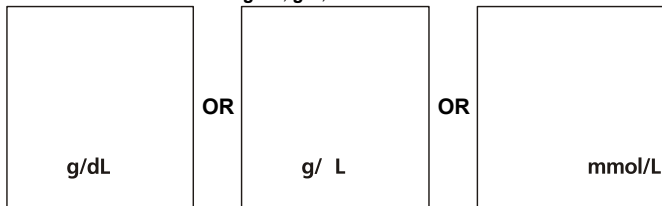

Press ⏻ to save and proceed to setup sound.

Sound Setup

Press ◀ or ▶ to turn the sound **ON** or **OFF**. The Sound Symbol will appear on the display when the sound is turned on. Press ⏻ to save and return to the setup screen.

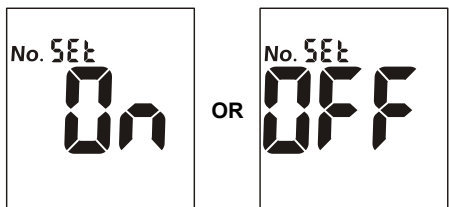

Press ◀ or ▶ until **Elit** is displayed and press ⏻ to exit setup. The screen will briefly go blank and display the initial screen.

Section 6 Testing

Before performing any test, review the Clarity HbCheck Hemoglobin meter User's manual. Review **Section 9 Quality Control** for detailed instructions on running quality control tests to ensure that results are within range prior to reporting test results.

The following steps show how to use each component to measure the Hemoglobin concentration.

Specimen Collection

The Clarity HbCheck Hemoglobin Meter requires a very small specimen. This may be obtained from fresh capillary whole blood. EDTA or sodium heparin-anticoagulated venous whole blood may be used as well. Before testing, choose a clean, dry work surface. Review the procedure. Make sure all of the items needed to obtain a drop of blood are available.

Venous Blood Testing

For fresh whole venous blood specimens, collect the venous blood in a closed container with EDTA-K2, EDTA-K3, and EDTA-Na2 or sodium heparin anticoagulants. Mix the specimen well. Then collect approximately 10 μ L into a capillary transfer tube. Apply it to the center hole of the specimen application area of the cartridge. Do not touch the test cartridge with the tube.

- Whole Blood must be tested within 8 hours of collection.
- Mix the specimen well before testing. This is to ensure the cellular components are evenly distributed.
- Allow the specimen to reach a temperature between 59-86 °F (15-30 °C), approximately 15 minutes if the specimen has been refrigerated.
- Anticoagulants other than EDTA-K2, EDTA-K3, EDTA-Na2 and sodium heparin are not recommended for use.

Note: Refer to the Clinical and Laboratory Standards Institute (CLSI) Documents H3-A6, Collection of Diagnostic Blood Specimens by Venipuncture.

Fingertip Blood Testing

Here is an example of how to use a Safety Lancet for fingertip blood sampling. If you use a different single-use auto-disabling safety lancet, please follow the manufacturer's instructions.

Note: Only single-use auto-disabling safety lancets should be used for fingertip blood sampling.

1. Carefully rotate and pull off the protective cap. Avoid placing your thumb or fingers over the uncapped end of the safety lancet.
2. Hold the safety lancet against the puncture site. **Note:** Before using a **single-use auto-disabling safety lancet** for blood sampling, wash both hands with soap and warm water and disinfect the puncture site with a topical skin antiseptic such as an alcohol swab.

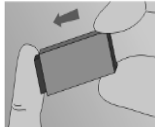
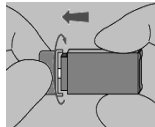

3. Gently press the safety lancet against the puncture site to lance the skin. Listen for an audible click. This indicates that the safety feature of the device has been activated. Dispose of the lancet in an appropriate biohazard sharps container. Please see the **Caution Statement**.

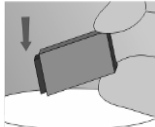

4. Gently massage from the surrounding area toward the puncture site to collect the required blood volume.

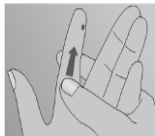

For the greatest reduction in pain, lance on the sides of the fingertips. Rotation of sites is recommended. Repeated punctures in the same spot can make fingers sore and callused.

5. Wipe away the first drop of blood. Apply light pressure to obtain a second drop of blood. Collect 10 μL of capillary blood using a capillary transfer tube

Note: Refer to the Clinical and Laboratory Standards Institute (CLSI) Documents H04-A6, Collection of Diagnostic Blood Specimens by Skin Puncture.

6. To use a capillary transfer tube, hold the tube slightly downward and touch the tip to the blood specimen. Capillary action will automatically draw the specimen to the fill line and stop.

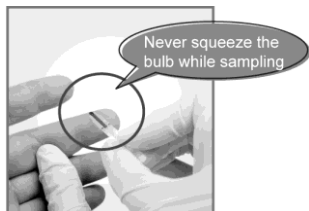
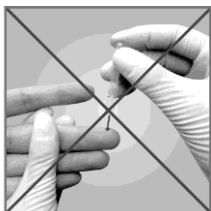

Note: The capillary transfer tube will fill automatically. Never squeeze the tube while sampling.

Note: Make sure the blood covers the air vent of the tube, or it will be hard to squeeze blood out.

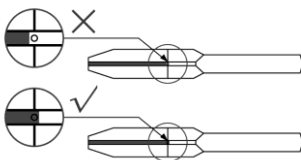

7. Align the tip of the capillary transfer tube with the center hole of the specimen application area of the test cartridge. Apply the collected drop of blood (approximately 10 μ L) here.



Note: Do not touch the test cartridge with the capillary transfer tube. The capillary blood should be tested immediately after being collected. Use of a capillary transfer tube is recommended for accurate results.

Caution Statement

- Do not use the single-use auto-disabling safety lancet if the cap is missing or loose.
- Always use a new, sterile single-use auto-disabling safety lancet. Do not reuse the single-use auto-disabling safety lancet.
- Avoid getting the single-use auto-disabling safety lancet dirty with hand lotion, oil, dirt or debris.
- Single-use auto-disabling safety lancets appropriate biohazard sharps container. If a biohazard sharps container is not available use a heavy duty plastic container such as a laundry detergent bottle. Ensure the container is leak-resistant and has a hard puncture proof lid. Do not place loose sharps into the trash and do not flush down the toilet. Do not place sharps into the recycle bin as they are not recyclable.

Test Processing

1. Ensure the meter is set up properly, as described in previous sections. Turn the meter on. The screen will briefly display all of the LCD symbols. Observe the LCD at startup to ensure all segments and display elements are turned on. There should be no missing icons or elements. The meter will briefly show a blank display. Ensure that no segments or icons are permanently turned on.

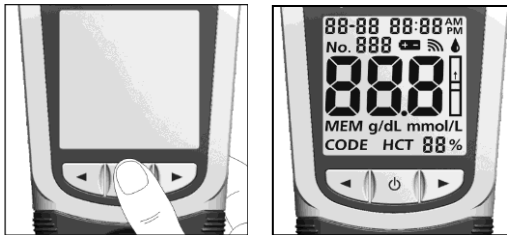

After startup, the initial screen will be displayed. Ensure the code chip is inserted. Compare the number showed on the display with the code number printed on the canister label. Refer to **Section 4 Coding the Meter**.

2. The **Test Cartridge Symbol** will flash when the meter is ready for the test cartridge to be inserted.

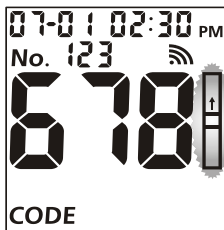

3. To test with a test cartridge, insert the cartridge into the cartridge channel. Enter the cartridge in the same direction as the arrow on the test cartridge indicates. Ensure that the test cartridge is inserted all the way to the end of the cartridge channel.



4. The **Blood Drop Symbol** will flash when the meter is ready for the specimen to be applied. Apply 10 μL of blood to the center hole of the specimen application area of the test cartridge.



Note: When testing capillary blood, the blood sample should be tested immediately after being collected.

5. The meter will begin testing automatically; three dashes in a line flash will appear on the display. This indicates that the test is in progress.

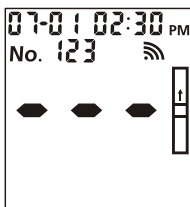

The **Hb** and the estimated **Hct** value will be displayed within 15 seconds. The **Hct** value will be displayed at the bottom of the screen.

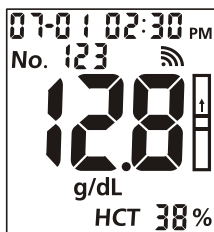

If the concentration of hemoglobin is below 4.5 g/dL, the meter will display **Lo**. The meter will display **Hi** if the concentration is above 25.6 g/dL.

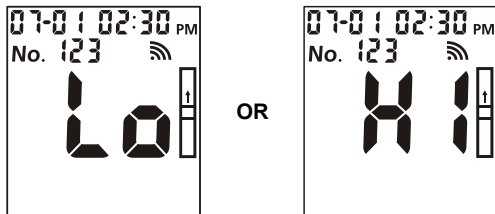

Note: All results below 5.6 g/dL or above 23.5 g/dL must be confirmed by a suitable laboratory method.

The hematocrit value is calculated using the formula $Hct = F \times Hgb$ [g/dL], with $F = 2.94$. A true hematocrit test is not determined with this System.

Note: The use of this formula is allowed only within the normal hemoglobin range, means from 12.3 g/dL (7.63 mmol/L) - 17.5 g/dL (10.86 mmol/L)^{1,2}. If the Hb result is outside this range then the estimated hematocrit result will not be calculated and "--" will appear.

6. Remove the used test cartridge. The meter will then return to the initial screen. This indicates the meter is ready for a new test cartridge to be inserted and another test performed.

Note: Dispose of all blood specimens, used test cartridges, and materials carefully. Treat all blood specimens as if they were infectious materials. Follow proper precautions and obey all local regulations when discarding blood specimens and materials.

7. Perform daily cleaning when testing is completed for the day. Refer to **Section 10 Maintenance**.

8. The meter will automatically turn off after 8 minutes of inactivity or when  is pressed. If the meter is powered with an AC Adaptor, turn off the meter before removing it from the power outlet. Remove the batteries if the meter will not be used for an extended period of time.

1. *John Bernard Henry, Clinical Diagnosis and Management by Laboratory Methods. Twentieth Edition, Page 485.*
2. *Clinical Principles and Applications, 2007 edition. ISBN-13: 976-1-4160-3006-5, page 169.*

Section 7 Meter Memory

Viewing Memory

From the initial screen (refer to **Section 6 Testing**), press ◀ or ▶ to show the first record.

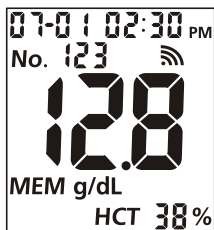

Press ◀ or ▶ to view each record in date/time sequence. Press and hold  to return to the Initial Screen.

If no data is stored, the meter will display one dash (-) and **MEM**.

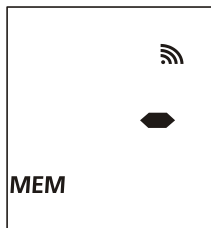

Note: Up to 999 test records are automatically stored in the memory. After 999 test records are stored, the oldest test record will be replaced by a new record. For example, if 999 records are stored in memory, the next test result (1,000) will replace the first result stored in the memory.

Deleting Data

To delete all data from the meter's database, enter the setup menu (refer to **Section 5 Meter Setup**). Press ◀ or ▶ until **dEL** is displayed.

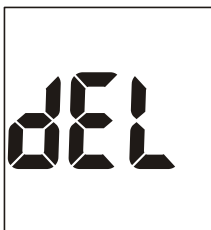

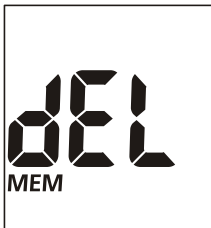

Press  to enable data deletion. **MEM** will be displayed.



Section 8 Optical System Check

1. With the meter turned off, press and hold  for 4 seconds to enter the **Meter Setup** mode shown below.



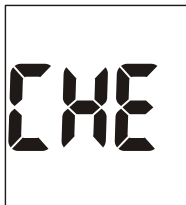

2. Press  or  from the setup screen to select the **Optical Check** mode as shown below.

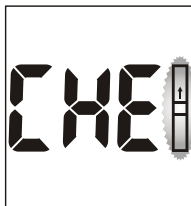

Note:

- The optical verifier is intended for checking the optical system.
 - Allow the optical verifier and the meter to reach a temperature between 59 - 86 °F (15 - 30 °C) prior to testing.
 - The optical check should be performed under normal lab lighting conditions. Do not perform under sunlight or extreme lighting conditions.
3. Press  to enter this mode. The meter will flash the test cartridge symbol as shown below.



4. Insert an optical verifier into the cartridge channel. Enter the optical verifier in the same direction as the arrow on the verifier indicates. Ensure that the optical verifier is inserted all the way to the end of the cartridge channel. Press  to start the optical check. If the meter displays **YES**, the meter is normal. If the meter displays **no**, the meter is not functioning properly.

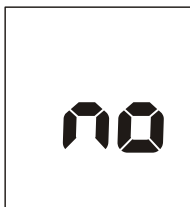

If the meter displays **no**, check the optical verifier for contamination or to see if it is damaged. If there are visible signs of damage or contamination, discard the optical verifier and retest using a new optical verifier. If the optical verifier is ok, check the sensor area of the meter for contamination. If dirty, clean the sensor area then test with a new optical verifier. Refer to **Section 10 Maintenance** to clean the meter sensor area.

Note: Please contact Customer/Technical Support at 1-877-485-7877 if the meter displays no again to double check if there are any problems with the system.

5. Press  to return to the Setup Screen.

Section 9 Quality Control Testing

Each lab should use its own standards and procedures to perform quality controls. Test known specimens or controls, at each of the following events, in accordance with local, state, and/or federal regulations or accreditation requirements.

- Each new day of testing
- A new canister of test cartridges is opened
- A new operator
- Test results seem inaccurate
- After performing maintenance or service on the meter

If QC tests do not provide expected results, perform the following checks:

- Ensure the test cartridges used are not past their expiration date.
- Ensure the test cartridges are fresh from a new canister.
- Ensure the controls are not past their expiration date.
- Repeat the test to ensure no errors were made during previous quality control testing.

Please contact Customer/Technical Support at 1-877-485-7877 for additional information.

Control Solution Testing

Hb Control Solution testing is performed in a very similar manner to blood tests, using the Clarity HbCheck Hemoglobin Control Solutions instead of blood.

Note: Allow all test materials to reach a temperature between 59 - 86 °F (15 - 30 °C) prior to testing. Invert the control solution vial back and forth for at least 15 minutes.

1. Compare the code number on the code chip with the code number printed on the test cartridge canister label, and ensure the numbers are identical to avoid inaccurate results. Turn on the meter; insert the code chip into the meter.
2. Remove a test cartridge from the closed canister and use it as soon as possible. Immediately close the canister tightly after removing the required number of test cartridges.
Wait for the meter to flash the **Test Cartridge Symbol**. Insert the test cartridge completely into the cartridge channel in the same direction as the arrows printed on the test cartridge.
3. While the meter is flashing the **Blood Drop Symbol**, use a capillary transfer tube to apply 10 µl of the control solution to the center of the specimen application area. Three dashes will appear on the meter to show the test is in progress.
4. Read the results on the screen after 15 seconds.

Interpreting results

If the result is within the range printed on the Clarity HbCheck Hemoglobin Control Solution vial label, the meter and test cartridges are performing properly.

All three levels of control solutions (CTRL 0, CTRL 1 and CTRL 2) must be tested and all levels have to be within the assigned value ranges.

If the Hb value is outside of the range printed on the control solution vial label or if the meter is displaying an error message, see the **Control Solution Package Insert** for further instructions.

Please contact Customer/Technical Support at 1-877-485-7877 for additional information.

Precautions

- Use only a Clarity HbCheck Hemoglobin control solution with a Clarity HbCheck Hemoglobin Meter and Test Cartridges.
- For *in vitro* diagnostic use only. Do not use after the expiration date.
- Shake well and let the controls reach a temperature between 59 - 86 °F (15 - 30 °C) prior to testing.
- All materials should be considered potentially hazardous and handled in the same manner as an infectious agent.
- The used materials should be discarded according to local regulations after testing.
- This product is not intended for use as a standard.
- The use of quality control materials is an important part of good laboratory practices. Quality control materials are an objective method of assessing techniques or practices in use.
- Control solution tests are designed to be accurate only when tested between 59-86 °F (15-30 °C).
- Check the code chip before performing a test. Make sure to use the right code chip. Insert the code chip into the code chip slot. The code chip slot is located on the right side of the meter.

Section 10 Maintenance

Proper maintenance is recommended for best results.

Cleaning

For best results, the meter should be cleaned after each day of testing.

Meter Surface

A cotton cloth can be used to clean the surface of the meter & LCD. Use a damp cotton cloth, if necessary. It is recommended that the meter be stored in the carrying case after each use.

Avoid getting liquids, residue, or control solutions in the meter through the cartridge channel, code chip slot, or USB port.

Test Cartridge Holder

Remove the test cartridge holder by firmly pressing down on both sides of the test cartridge holder with your thumbs and sliding it out from the meter. See image below. Wipe the test cartridge holder with a damp cloth or a mild detergent, such as diluted liquid soap, dishwashing liquid, or alcohol wipes. Dry it with a dry, soft cloth. Slide the test cartridge holder back into the meter by laying it flat on the meter. Press down on both sides of the test cartridge holder with your thumbs. Push it in until it clicks back into place.

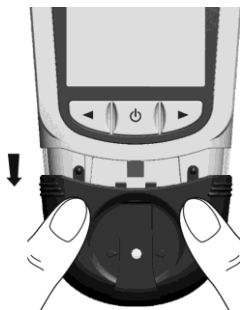

Note: Do not use organic solvents such as acetone, hexane, citrus terpenes; it will cause damage to the meter.

Meter Sensor Area

A dry, soft cloth may be used to clean and the sensor area. Remove the test cartridge holder as described in the previous section. Wipe down the meter sensor area with a humid cotton swab if needed. Do not scratch the transparent window covering the sensor.



Note: Do not use bleach or alcohol to clean the meter sensor area. This would cause damage to the meter.

Disinfection Process

The disinfection process should be performed before **each test** to prevent potential infectious disease transmissions through blood borne pathogens.

Cleaning before Disinfection

First use Oxivir[®] Tb wipes to clean the entire meter surface. (EPA Registration No. 70627-60) Wipe the meter down to remove any stains or debris. This cleaning is to prepare the meter surface for the disinfection process.

Disinfection

Then use a second fresh Oxivir[®] Tb wipe to wipe the entire meter surface. Make sure the meter surface is thoroughly damp. Please refer to the diagram of the meter in the **Section 2 Getting Started** for the meter surface illustration.

The outer meter surface must remain visibly wet for one full minute to effectively disinfect. After disinfection, please allow the meter to air dry completely before using the meter again.

Note: Avoid inserting the Oxivir® Tb wipe inside of the cartridge channel, code chip slot and USB port while cleaning before disinfection and while disinfecting the meter. Please refer to **Section 3 Components** for the cartridge channel, code chip slot and USB port locations.

Disinfection Wipes and Where to Buy Them

The suggested wipes for your meter pre-cleaning and disinfection are the Oxivir® Tb wipes (EPA Registration No. 70627-60). Oxivir® Tb wipes are available through your cleaning solutions distributor or at online retailers such as www.detergentsolutions.com.

Cleaning and Disinfection Frequency

The meter disinfection process has been validated through repeated disinfection cycles, which is equivalent to 3 years of meter usage. This is to ensure that your meter will operate properly, even with the disinfection process applied to it for 3 years. You should always check to ensure all display segments appear when you turn the meter on. This means your meter is properly working. However, if you have any problem with your meter, contact Customer/Technical Support at 1-877-485-7877.

Note: All parts of the kit are considered biohazardous. They can potentially transmit infectious diseases, even after you have performed cleaning and disinfection. Please follow proper precautions when handling the meter. Although it has not been observed, some alterations may appear on the meter due to the cleaning and disinfection procedure. Such as: cloudy display window, plastic housing cracking, meter buttons not functioning, partial display on full screen, unable to execute the meter's initial set up, etc. Stop using the meter and contact Customer/Technical Support at 1-877-485-7877 for assistance.

Replacing the Batteries

When the battery icon  is flashing, the batteries are running low and should be replaced as soon as possible. An **E-4** error message will appear if the batteries are too low to perform tests. The meter will not function until the batteries are replaced.



Make sure the meter is turned off before removing the batteries. Turn the meter over to locate the battery cover. Press the battery cover tab at the bottom of the cover and lift the cover to open it. Remove and discard the old batteries. Insert 4 new AAA batteries according to the diagram inside the battery compartment. Insert 4 new AAA batteries according to the diagram inside the battery compartment.



Close the battery cover and make sure that it snaps shut. Re-check and reset the clock setting, if necessary, after replacing the batteries to ensure time is set correctly. Refer to **Section 4 Initial Setup**.

Note: Do not discard batteries with household waste. Follow local regulations for disposal.

Section 11 Precautions

Observe the precautions listed below to ensure accurate results and proper operation of the meter:

- The protection provided by the meter may be impaired if used in a manner not defined in this instruction manual.
- Wear gloves to avoid contact with potentially hazardous biological specimens during testing.
- Avoid storing or operating the meter in direct sunlight, excessive temperatures, or high humidity. Refer to **Appendix 1 Specifications** for operating condition requirements.
- Keep the meter clean. Wipe it frequently with a soft, clean, and dry cloth. Use a damp cotton cloth, if necessary.
- Do not use organic solvents, such as acetone, hexane, citrus terpenes; it will cause damage to the meter.
- Do not clean the LCD or meter sensor area with water. Lightly wipe with a soft, clean dry rag. Use a damp cotton cloth, if necessary.
- The cartridge channel must be kept clean. Lightly wipe it with a soft, clean dry rag each day. Use a damp cotton cloth or a mild detergent as needed. Refer to **Section 10 Maintenance**.
- Follow all local regulations when discarding the unit or its accessories.
- Do not use the system outside of the operating temperature ranges listed below.

59 - 86 °F (15 - 30 °C); ≤90% RH

Section 12 Troubleshooting

Display	Causes	Solution
E-1	The sensor area is damaged, dirty, or blocked at turn-on. This can include a used test cartridge left in the meter.	Ensure the sensor area is clean. There should be no objects covering the sensor area. Refer to Section 10 Maintenance . Restart the meter. Contact Customer/Technical Support at 1-877-485-7877 if the sensor area window is broken.
E-2	Test cartridge was removed during the test.	Repeat the test. Ensure the test cartridge remains in place.
E-3	Specimen was applied to the test cartridge too soon.	Repeat the test. Apply specimen after the blood drop symbol appears.
E-4	Batteries are discharged and the meter will not allow more tests until the batteries are replaced.	Replace the batteries, or connect the meter to the AC Adapter, then repeat the test.
E-5	Insufficient specimen.	Repeat the test. Apply enough specimen. Use 10 μ L of whole blood.
E-6	Expired test cartridge. Date programmed into the meter is incorrect	Ensure the test cartridges are within the expiration date printed on the canister label. Set up the meter again and enter the correct date.
E-7	Code chip was removed during testing.	Insert proper code chip. Confirm the code chip matches the test cartridge code and repeat the test.
+ -	Batteries are low, but have enough power to run 20 more tests.	Test results will still be accurate. Replace the batteries as soon as possible.
Lo	The test result is lower than 4.5 g/dL (45 g/L or 2.8 mmol/L).	If the specimen was taken from a specimen container, ensure the specimen is mixed well and repeat test.
	Insufficient specimen less than 10 μ L.	Repeat the test. Apply enough specimen. Use around 10 μ L of whole blood.
Hi	The test result is higher than 25.6 g/dL (256 g/L or 15.9 mmol/L).	If the specimen was taken from a specimen container, ensure the specimen is mixed well and repeat test.
--- CODE	No code chip in the meter; Code chip is damaged or inserted incorrectly.	Insert the code chip that is included in the box of test cartridges. If the code chip is damaged, use a new code chip with the correct code number. If the code chip is inserted incorrectly, remove the code chip and insert it into the code chip slot.

Please contact Customer/Technical Support at 1-877-485-7877 for details.

Appendix 1 Specifications

Feature	Specifications
Methodology	Reflectance Photometer
Test Time	<15 seconds
Measurement Range	5.6 - 23.5 g/dL
Specimen	Whole blood
Specimen Volume	10 µL
Power Source	4 AAA batteries (1.5 V)
	AC Adapter – Not included
Battery Life	360 hours or 2,700 tests
Units of Measure	g/dL, g/L, mmol/L
Memory	1,000 records
Automatic Shut Off	8 minutes after last action
Meter Size	5.4" × 3.11" × 1.02" (137 mm × 79 mm × 26 mm)
Display Size	1.97" × 1.97" (50 mm × 50 mm)
Weight	145 g (without batteries)
Operating Conditions	59 - 86 °F (15 - 30 °C); ≤90% RH

Appendix 2 Warranty

Please complete the warranty card that came with this product and mail it to the following address within 30 days of the date of purchase to register your meter:

Clarity HbCheck Warranty Center

Clarity Diagnostics, LLC.

33 SE 8th Street, Suite A

1701 Green Rd, Suite A Deerfield Beach, FL 33064

If the meter fails to work for any reason other than obvious abuse within the first 3 years from purchase, we will replace it with a new meter free of charge. For your records, also write the purchase date of your product here.

Date of purchase: _____

Note: This warranty applies only to the meter in the original purchase. It does not apply to the other materials included with the meter.

Clarity Diagnostics, LLC. warrants to the original purchaser that this meter will be free from defects in materials and workmanship for a period of three years (36 months). The three years starts from the date of original purchase or installation (except as noted below). During the stated three year period, **Clarity Diagnostics, LLC.** shall replace the meter under warranty with a reconditioned meter or, at its option, repair at no charge a meter that is found to be defective. **Clarity Diagnostics, LLC.** shall not be responsible for shipping charges incurred in the repair of a meter.

This Warranty is subject to the following exceptions and limitations:

This warranty is limited to repair or replacement due to defects in parts or workmanship. Parts required which were not defective shall be replaced at additional cost. **CLARITY DIAGNOSTICS, LLC.** shall not be required to make any repairs or replace any parts that are required because of abuse, accidents, alteration, misuse, neglect, failure to operate the meter in accordance with the user's manual, or maintenance by anyone other than **CLARITY DIAGNOSTICS, LLC.** Furthermore, **CLARITY DIAGNOSTICS, LLC.** assumes no liability from malfunction or damage to meters caused by the use of Test Cartridges other than Test Cartridges manufactured by **CLARITY DIAGNOSTICS, LLC.** **CLARITY DIAGNOSTICS, LLC.** reserves the right to make changes in the design of this meter without obligation to incorporate such changes into previously manufactured meters.

Disclaimer of Warranties

This warranty is expressly made in lieu of any and all other warranties expressed or implied (either in fact or by operation of law). These may include the warranties of merchantability and fitness for use, which are expressly excluded, and is the only warranty given by **CLARITY DIAGNOSTICS, LLC.**

Limitations of Liability

In no event shall **CLARITY DIAGNOSTICS, LLC.** be liable for indirect, special, or consequential damages, even if **CLARITY DIAGNOSTICS, LLC.** has been advised of the possibility of such damages.

For warranty service, please contact Customer/Technical Support at 1-877-485-7877 for details.

CLARITY

© Clarity Diagnostics, LLC. All rights reserved. Manufactured for Clarity Diagnostics, LLC. 1701 Green Rd, Suite A Deerfield Beach, FL 33064
For questions call: 877.722.6339 | Technical Support: 877.485.7877
www.claritydiagnostics.com REV01-112013HB2

CLIA WAIVED

FOR *IN VITRO* DIAGNOSTIC USE ONLY.

CUSTOMER SERVICE: 877.722.6339

TECHINCAL SUPPORT: 877.485.7877